

G-8049H-C15E0-T

Finezza Uno Series

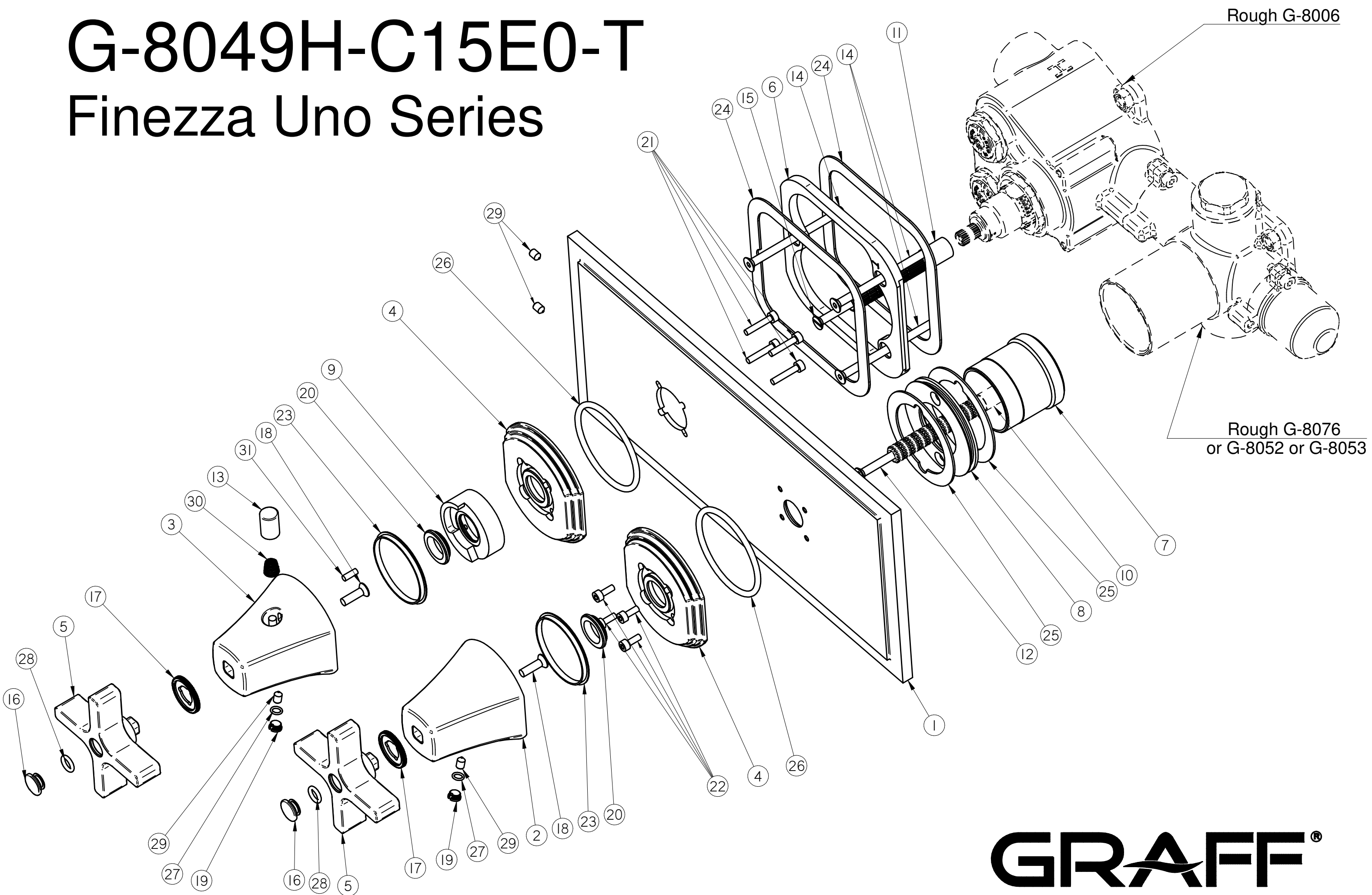

GRAFF[®]
CUTTING EDGE DESIGN